



Cylinders are a complete design solution. They are available in various sizes, mounting options, colors and beam angles, and suitable for indoor/outdoor use.

Color: Matte black

Weight: 4.2 lbs

Project:	Type:
Prepared By:	Date:

Driver Info		LED Info	
Type	Constant Current	Watts	20W
120V	0.18A	Color Temp	5000K (Cool)
208V	0.11A	Color Accuracy	92 CRI
240V	0.10A	R9	68
277V	0.09A	L70 Lifespan	50,000 Hours
Input Watts	19.8W	Lumens	1,800 lm
		Efficacy	90.9 lm/W

Technical Specifications

Compliance

UL Listed:

Suitable for wet locations. Recommended for indoor use only.

IESNA LM-79 & LM-80 Testing:

RAB LED luminaires and LED components have been tested by an independent laboratory in accordance with IESNA LM-79 and LM-80.

Electrical

Driver:

Constant Current, Class 2, 120-277V, 50/60 Hz, 120V: 0.18A, 208V: 0.11A, 240V: 0.10A, 277V: 0.09A

Dimming Driver:

0 - 10V (at 120-277V), TRIAC and ELV (at 120V only)

THD:

13.5% at 120V, 22.9% at 277V

Power Factor:

98.1% at 120V, 86% at 277V

Optical

Optics:

80°

Performance

Lifespan:

50,000-Hour LED lifespan based on IESIm-80 results and TM-21 calculations

LED Characteristics

LEDs:

Long-life, high-efficacy, surface-mount LEDs

Color Stability:

LED color temperature is warranted to Shift no more than 200K in color temperature over a 5-year period

Construction

Cold Weather Starting:

The minimum starting temperature is -22°F (-30°C)

Maximum Ambient Temperature:

Suitable for use in up to 104°F (40°C)

Lens:

Solite Glass Lens and Microprismatic Diffusion Lens

Reflector:

Vacuum-metalized polycarbonate

Housing:

Extruded aluminum

Gaskets:

High-temperature silicone

Green Technology:

Mercury and UV free. RoHS-compliant components.

Finish:

Formulated for high durability and long-lasting color

Installation

Mounting:

Pendant cord (48" standard, cut to length in field)

Other

5-Year, No-Compromise Warranty:

RAB warrants that our LED products will be free from defects in materials and workmanship for a period of five (5) years from the date of delivery to the end user, including coverage of light output, color stability, driver performance and fixture finish. RAB's warranty is subject to all terms and conditions found at rablighting.com/warranty.

Dimensions

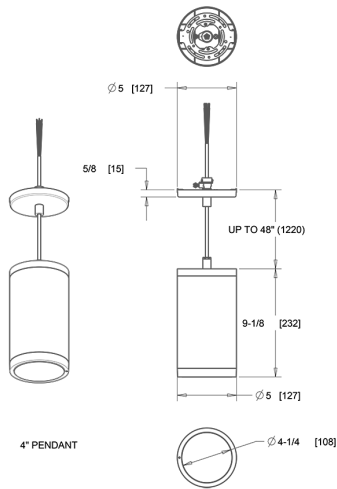

Features

- Sleek, contemporary, architectural-grade design
- Universal dimming driver (TRIAC, ELV and 0-10V)
- 50,000-Hour LED lifespan

Ordering Matrix

Family	Size	Mounting	Wattage	Optic	CRI/Color Temp	Finish
CDLED	4	PC	20W	80D	950	K
	4 = 4" 6 = 6" 2 = 2"	W = Wall Direct/Indirect (Downlight/Uplight) PS = Pendant Stem PC = Pendant Cord 48" Standard S = Surface (Ceiling Mount) WU = Wall Indirect (Uplight) Only WD = Wall Direct (Downlight) Only	20W = 20W 10W = 10W 26W = 26W 40W = 40W	40D = 40° 20D = 20° 30D = 30° 50D = 50° 80D = 80° WW = Wall Wash	950 = 90 CRI, 5000K 940 = 90 CRI, 4000K 935 = 90 CRI, 3500K 930 = 90 CRI, 3000K 927 = 90 CRI, 2700K	W = Matte White K = Matte Black S = Matte Silver Z = Bronze