



Cylinders are a complete design solution. They are available in various sizes, mounting options, colors and beam angles, and suitable for indoor/outdoor use.

Color: Matte black

Weight: 5.8 lbs

Project:	Type:
Prepared By:	Date:

Driver Info		LED Info	
Type	Constant Current	Watts	40W
120V	0.30A	Color Temp	3000K (Warm)
208V	0.22A	Color Accuracy	91 CRI
240V	0.19A	R9	51
277V	0.14A	L70 Lifespan	50,000 Hours
Input Watts	35W	Lumens	3,308 lm
		Efficacy	94.5 lm/W

Technical Specifications

Compliance

UL Listed:

Suitable for wet locations

IESNA LM-79 & LM-80 Testing:

RAB LED luminaires and LED components have been tested by an independent laboratory in accordance with IESNA LM-79 and LM-80.

Electrical

Driver:

Constant Current, Class 2, 120-277V, 50/60 Hz, 120V: 0.30A, 208V: 0.22A, 240V: 0.19A, 277V: 0.14A

Dimming Driver:

0 - 10V (at 120-277V), TRIAC and ELV (at 120V only)

THD:

12.5% at 120V, 19.7% at 277V

Power Factor:

98.4% at 120V, 89.9% at 277V

Optical

Optics:

80°

Performance

Lifespan:

50,000-Hour LED lifespan based on IESIm-80 results and TM-21 calculations

LED Characteristics

LEDs:

Long-life, high-efficacy, surface-mount LEDs

Color Stability:

LED color temperature is warranted to Shift no more than 200K in color temperature over a 5-year period

Construction

Cold Weather Starting:

The minimum starting temperature is -22°F (-30°C)

Maximum Ambient Temperature:

Suitable for use in up to 104°F (40°C)

Lens:

Solite Glass Lens and Microprismatic Diffusion Lens

Reflector:

Vacuum-metallized polycarbonate

Housing:

Extruded aluminum

Gaskets:

High-temperature silicone

Green Technology:

Mercury and UV free. RoHS-compliant components.

Finish:

Formulated for high durability and long-lasting color

Installation

Mounting:

Wall direct/indirect light

Other

5-Year, No-Compromise Warranty:

RAB warrants that our LED products will be free from defects in materials and workmanship for a period of five (5) years from the date of delivery to the end user, including coverage of light output, color stability, driver performance and fixture finish. RAB's warranty is subject to all terms and conditions found at rablighting.com/warranty.

Dimensions

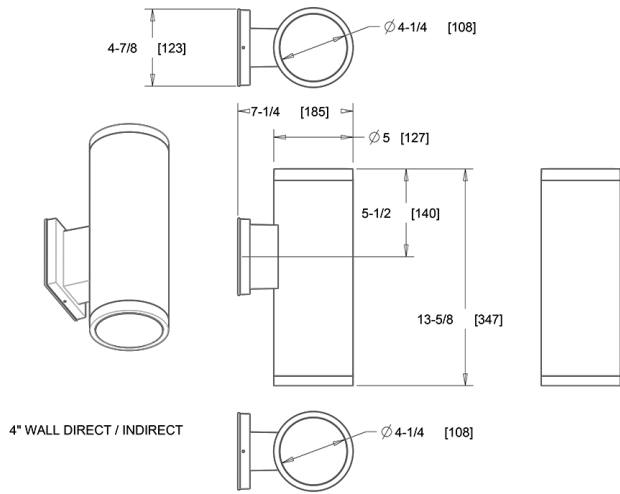

Features

- Sleek, contemporary, architectural-grade design
- Universal dimming driver (TRIAC, ELV and 0-10V)
- 50,000-Hour LED lifespan

Ordering Matrix

Family	Size	Mounting	Wattage	Optic	CRI/Color Temp	Finish
CDLED	4	W	40W	80D	930	K
	4 = 4"	W = Wall Direct/Indirect (Downlight/Uplight)	20W = 20W	40D = 40°	950 = 90 CRI, 5000K	W = Matte White
	6 = 6"	PS = Pendant Stem	10W = 10W	20D = 20°	940 = 90 CRI, 4000K	K = Matte Black
	2 = 2"	PC = Pendant Cord 48" Standard	26W = 26W	30D = 30°	935 = 90 CRI, 3500K	S = Matte Silver
		S = Surface (Ceiling Mount)	40W = 40W	50D = 50°	930 = 90 CRI, 3000K	Z = Bronze
		WU = Wall Indirect (Uplight) Only		80D = 80°	927 = 90 CRI, 2700K	
		WD = Wall Direct (Downlight) Only		WW = Wall Wash		