

INSTRUCTIONS

8" CCT-Adjustable DISK34 Installation

RAB®

RAB Lighting is committed to creating high-quality, affordable, well-designed and energy-efficient LED lighting and controls that make it easy for electricians to install and end users to save energy. We'd love to hear your comments. Please call the Marketing Department at 888-RAB-1000 or email: marketing@rablighting.com

** DON'T TOSS IT—RECYCLE IT! MAKE THE SUSTAINABLE CHOICE BY RECYCLING THIS FIXTURE AT END OF LIFE WITH A LICENSED RECYCLING PROVIDER. **



DISK34-8

IMPORTANT

READ CAREFULLY BEFORE INSTALLING FIXTURE. RETAIN THESE INSTRUCTIONS FOR FUTURE REFERENCE.

RAB fixtures must be wired in accordance with the National Electrical Code and all applicable local codes. Proper grounding is required for safety. THIS PRODUCT MUST BE INSTALLED IN ACCORDANCE WITH THE APPLICABLE INSTALLATION CODE BY A PERSON FAMILIAR WITH THE CONSTRUCTION AND OPERATION OF THE PRODUCT AND THE HAZARDS INVOLVED.

WARNINGS:

- Risk of electrical shock. Disconnect power at fuse or circuit breaker before installing or servicing.
- To prevent early lamp failure, lamp should only be installed in operating environments ranging between -30°C and +40°C (-22°F and +104°F).
- No user serviceable parts inside. To avoid electrical shock do not disassemble product.
- Risk of fire or electric shock, LED Retrofit Kit installation requires knowledge of luminaires electrical systems. If not qualified, do not attempt installation. Contact a qualified electrician.
- Do not make or alter any open holes in an enclosure of wiring or electrical components during kit installation
- To prevent wiring damage or abrasion, do not expose wiring to edges of sheet metal or other sharp objects.
- Installers should not disconnect existing wires from lampholder terminals to make new connections at lampholder terminals, Instead installers should cut existing lampholder leads away from the lampholder and make new electrical connections to lampholder lead wires by employing applicable connectors.
- This retrofit kit is accepted as a component of a luminaire where the suitability of the combination shall be determined by authorities having jurisdiction.
- This device is not intended for use with emergency exits.
- This retrofit kits suitable for wet locations luminaires specified as below: Type Non IC; Type IC; Covered ceiling; Uncovered ceiling. Installers should examine all parts that are not intended to be replaced by the retrofit kit for damage and replace any damaged parts prior to installation of the retrofit kit.

NOTE 1: This equipment has been tested and found to comply with the limits for a Class B digital device, pursuant to part 15 of the FCC Rules. These limits are designed to provide reasonable protection against harmful interference in a residential installation. This equipment generates, uses and can radiate radio frequency energy and, if not installed and used in accordance with the instructions, may cause harmful interference to radio communications. However, there is no guarantee that interference will not occur in a particular installation. If this equipment does cause harmful interference to radio or television reception, which can be determined by turning the equipment off and on, the user is encouraged to try to correct the interference by one or more of the following measures:

- Reorient or relocate the receiving antenna.
- Increase the separation between the equipment and receiver.
- Connect the equipment into an outlet on a circuit different from that to which the receiver is connected.
- Consult the dealer or an experienced radio/TV technician for help.

NOTE 2: Any changes or modifications to this unit not expressly approved by the party responsible for compliance could void the user's authority to operate the equipment

WHAT'S IN THE BOX

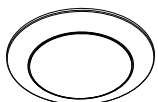

DISK34 (1)



Screws (2)



Nuts (3)



Bracket (1)

TOOLS NEEDED

Installation with J-BOX/Existing Housing

A screwdriver is needed for installation.

INSTRUCTIONS

8" CCT-Adjustable DISK34 Installation



RAB Lighting is committed to creating high-quality, affordable, well-designed and energy-efficient LED lighting and controls that make it easy for electricians to install and end users to save energy. We'd love to hear your comments. Please call the Marketing Department at 888-RAB-1000 or email: marketing@rablighting.com

**** DON'T TOSS IT—RECYCLE IT! MAKE THE SUSTAINABLE CHOICE BY RECYCLING THIS FIXTURE AT END OF LIFE WITH A LICENSED RECYCLING PROVIDER. ****

OPTIONAL ACCESSORIES

Our disk downlight is compatible with most common 5" and 6" recessed housing. The lamp socket kit is sold separately (Model # DSKFA6/PIR/ACC) which includes the E26 adapter, screws, nuts, and friction clips/torsion springs for installation in recessed housings.

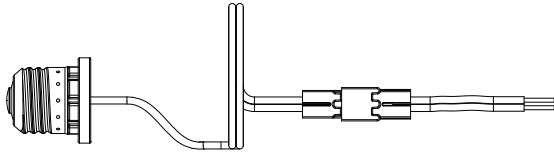

E26 adapter (1)

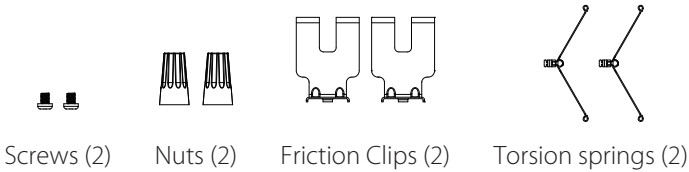

INSTALLATION WITH J-BOX

DISK34-8 compatible with 2.75" and 3.5" J-BOX.

1. Shut off power at the electrical panel before beginning the installation.
2. Remove lens by turning clockwise to unlock. Choose the appropriate color temperature (CCT) before installing the fixture. (Fig.1)

Fig: 1

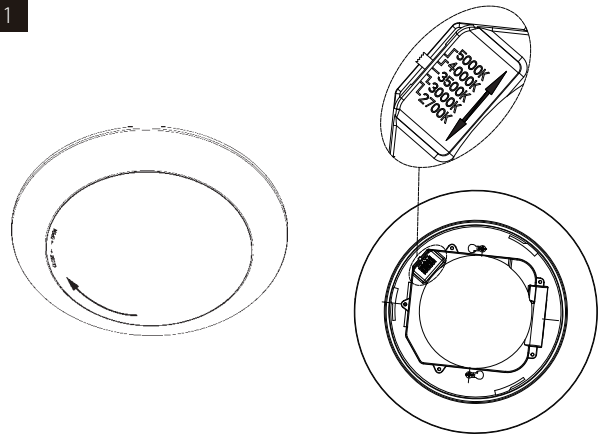

DIMENSIONAL DRAWINGS

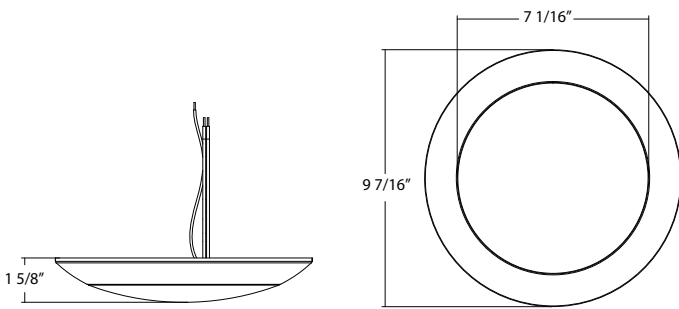

3. Lock the bracket on existing J-Box with both screws. (Fig.2)

Fig: 2

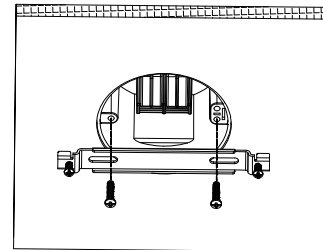

MIN. LAMP COMPARTMENT DIMENSIONS

Installation with J-BOX

J-box Min Volume - 12.56 in³ , Min Length: 3.2in, Height: 1.57in
Compatible with standard J-box

Installation with Existing Housing

Min lamp compartment dimensions - Dia: 5.05in, Height: 4.72in
Compatible with 5in and 6in recessed housing

Fig: 3

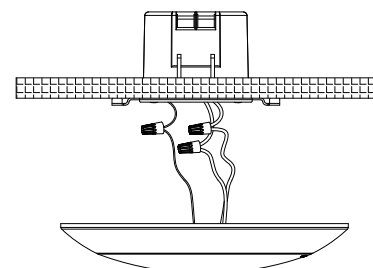

4. For surface mounting: Make the following electrical connections: Black wire to black wire. White wire to white wire. Ground wire to ground. Tuck wires inside the electrical box. (Fig.3)

Note: These instructions do not cover all details or variations in equipment nor do they provide for every possible situation during installation, operation or maintenance.

INSTRUCTIONS

8" CCT-Adjustable DISK34 Installation

RAB®

RAB Lighting is committed to creating high-quality, affordable, well-designed and energy-efficient LED lighting and controls that make it easy for electricians to install and end users to save energy. We'd love to hear your comments. Please call the Marketing Department at 888-RAB-1000 or email: marketing@rablighting.com

**** DON'T TOSS IT—RECYCLE IT! MAKE THE SUSTAINABLE CHOICE BY RECYCLING THIS FIXTURE AT END OF LIFE WITH A LICENSED RECYCLING PROVIDER. ****

INSTALLATION WITH J-BOX (cont'd)

5. Safely place all wires into the junction box, mount fixture to the junction box with supplied screws through the keyhole slots. (Fig.4)

Fig: 4

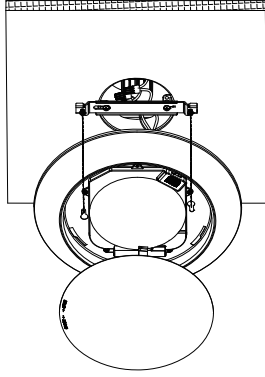

6. Replace lens and twist counter clockwise to lock. Caulk around the mounting surface edge with silicone sealant. (Fig.5)

Fig: 5

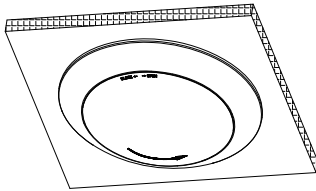

INSTALLATION WITH EXISTING HOUSING

1. Shut off power at the electrical panel before beginning the installation.

2. Remove lens by turning clockwise to unlock. Choose the appropriate color temperature (CCT) before installing the fixture. (Fig.6)

Fig: 6

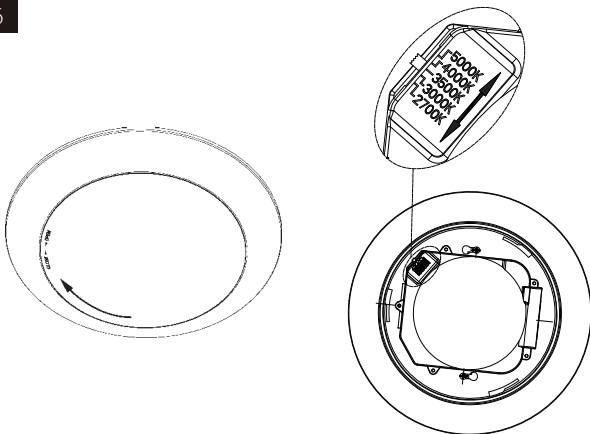

INSTALLATION WITH EXISTING HOUSING(cont'd)

3. Screw the bracket on the back of surface mount downlight. (Fig.7)

Fig: 7

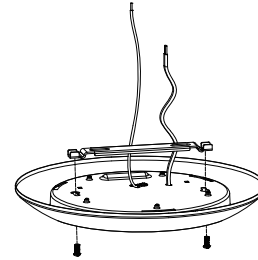

4. Recessed Can Installation: Attach the torsion springs(not included) to the bracket. Adjust arrow on the springs to align with the number on the fixture in order to achieve a tight fit inside the housing. (5" and 6" refers to the 5" and 6" can housing installation hole) (Fig.8)

Fig: 8

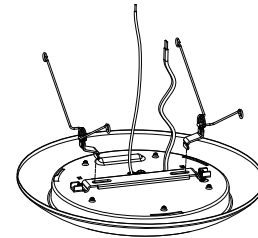

5. Put lens back on by twisting counter clockwise to lock. (Fig.9)

Fig: 9

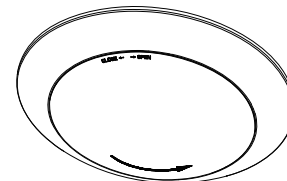

6. Make the following electrical connections: Black wire to black wire. White wire to white wire. Tuck wires inside the electrical box. (Fig.10)

Fig: 10

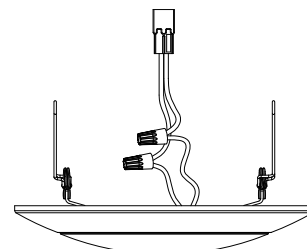

RAB Lighting is committed to creating high-quality, affordable, well-designed and energy-efficient LED lighting and controls that make it easy for electricians to install and end users to save energy. We'd love to hear your comments. Please call the Marketing Department at 888-RAB-1000 or email: marketing@rablighting.com

**** DON'T TOSS IT—RECYCLE IT! MAKE THE SUSTAINABLE CHOICE BY RECYCLING THIS FIXTURE AT END OF LIFE WITH A LICENSED RECYCLING PROVIDER. ****

INSTALLATION WITH EXISTING HOUSING(*cont'd*)

7. Screw E26 base adapter (not included) into socket in recessed housing, and simply slide the trim and torsion springs into the housing. (Fig.11)

Fig: 11

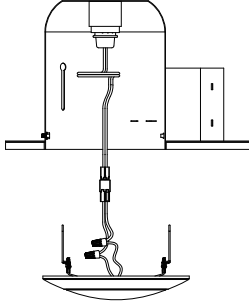

8. Carefully place wires into fixture and push the fixture into the housing until flush with ceiling. (Fig.12)

Fig: 12

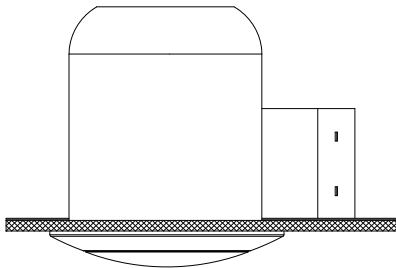

9. Caulk around the mounting surface edge with silicone sealant. (Fig.13)

Fig: 13

