



Color: Bronze

Weight: 55.6 lbs

<b>Project:</b>	<b>Type:</b>
<b>Prepared By:</b>	<b>Date:</b>

Driver Info		LED Info	
Type	Constant Current	Watts	534/445W
120V	4.45A	Color Temp	4000/5000K
208V	2.57A	Color Accuracy	84-86 CRI
240V	2.23A	L70 Lifespan	100,000 Hours
277V	1.93A	Lumens	56,195-69,674 lm
Input Watts	434.5-546.6W	Efficacy	118.1-137.2 lm/W

**Technical Specifications**

**Field Adjustability**

**Field Adjustable:**

Field Adjustable Light Output:  
534W/445W (factory default 534W)  
Color temperature (selectable by 4000K and 5000K)

**Compliance**

**UL Listed:**

Suitable for wet locations. Suitable for mounting within 4 ft (1.2m) of the ground.

**IP Rating:**

Ingress protection rating of IP66 for dust and water

**IESNA LM-79 & LM-80 Testing:**

RAB LED luminaires and LED components have been tested by an independent laboratory in accordance with IESNA LM-79 and LM-80.

**Trade Agreements Act Compliant:**

This product is a product of Cambodia and a "designated country" end product that complies with the Trade Agreements Act

**DLC Listed:**

This product family is listed with the DesignLights Consortium (DLC). Individual SKUs within this family may carry either a DLC Standard or DLC Premium qualification. Please refer to the individual product specification sheet or the DLC Qualified Products List (QPL) at [designlights.org](http://designlights.org) to confirm the qualification status of a specific SKU prior to specification or purchase.

**LED Characteristics**

**LEDs:**

Long-life, high-efficacy, discrete, surface-mount LEDs

**Color Consistency:**

7-step MacAdam Ellipse binning to achieve consistent fixture-to-fixture color

**Color Stability:**

LED color temperature is warranted to Shift no more than 200K in color temperature over a 5-year period

**Color Uniformity:**

RAB's range of Correlated Color Temperature follows the guidelines of the American National Standard for (SSL) Products, ANSI C78.377-2017.

**Electrical**

**Driver:**

445W: Constant Current, Class 2, 120-277V, 50/60 Hz, 120V: 3.71A, 208V: 2.14A, 240V: 1.86A, 277V: 1.61A

534W: Constant Current, Class 2, 120-277V, 50/60 Hz, 120V: 4.45A, 208V: 2.57A, 240V: 2.23A, 277V: 1.93A

**Dimming Driver:**

Driver includes dimming control wiring for 0-10V dimming systems. Requires separate 0-10V DC dimming circuit. Dims down to 10%.

**THD:**

3.33% at 120V, 7.28% at 277V

**Power Factor:**

99.9% at 120V, 98.4% at 277V

**Surge Protection:**

6 kV

**7-Pin Receptacle:**

ANSI C136.41 7-pin receptacle, compatible with wireless control systems

**Performance**

**Lifespan:**

100,000-Hour LED lifespan based on IESIm-80 results and TM-21 calculations

## Technical Specifications (continued)

### Wattage Equivalency:

534W: 2000W Metal Halide

445W: 2000W Metal Halide

### Optical

#### NEMA Type:

NEMA Beam Spread 3H x 3V

### Construction

#### Cold Weather Starting:

The minimum starting temperature is -40°F (-40°C)

#### Ambient Temperature :

Max Power Temp Rating: 104°F (40°C)

Low Power Temp Rating: 49.7°C (121.5°F)

#### Housing:

Die-cast aluminum

#### Tilt Increment:

Rotates in 5 degree increments

#### Lens:

Ultra clear, tempered glass

#### Reflector:

Vacuum metalized die cast aluminum alloy

#### Vibration Rating:

3G vibration rating per ANSI C136.31

#### Effective Projected Area (EPA):

EPA = 1.02

#### Gaskets:

High-temperature silicone gaskets

#### Finish:

Formulated for high durability and long-lasting color

#### Green Technology:

Mercury and UV free. RoHS-compliant components.

### Installation

#### Mounting:

2 3/8" slipfitter mount with stainless steel hardware

### Other

#### 10-Year, No-Compromise Warranty:

RAB warrants that our LED products will be free from defects in materials and workmanship for a period of ten (10) years from the date of delivery to the end user, including coverage of light output, color stability, driver performance and fixture finish. RAB's warranty is subject to all terms and conditions found at [rablighting.com/warranty](http://rablighting.com/warranty).

Dimensions

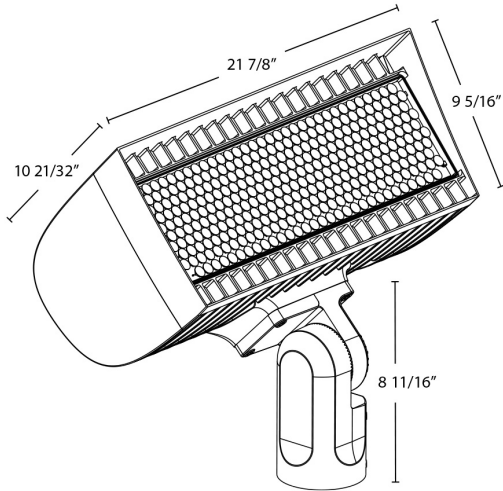

Features

- 100,000-hour life based on LM-80 results and TM-21 calculations
- DLC Premium Listed
- IP66 Rating protects against dust & water ingress
- 10-Year, No-Compromise Warranty

Ordering Matrix

Family	Housing Size	Color Temp	NEMA Type	Mounting	Finish	Driver	Options
FXLED	L		B33	SF			/7PR
	XS = Field Adjustable 80/60/40W S = Field Adjustable 168/132/97/69W M = Field Adjustable 346/213W L = Field Adjustable 534/445W	Blank = 3000/4000/5000K CCT Adjustable	Blank = 6H x 6V (XS&S) or 7H x 6V (M&L) B33 = 3H x 3V <sup>1</sup> B55 = 5H x 5V <sup>1</sup>	SF = Slipfitter T = Trunnion	Blank = Bronze W = White	Blank = 120-277V, 0-10V Dimming /480 = 480V, 0-10V Dimming	Blank = No Option /7PR = 7-Pin receptacle

<sup>1</sup> Available on medium (M) and large (L) sizes only