



Fits decorator wall plates with only 1/2" protrusion. Gangable. Sensitive 180° view passive infrared motion detector keeps lights on only when rooms are in use covers 1000 sq. ft Works with electronic ballasts. Can be wired in parallel. LED indicator, wallplate included. Can also be used as a ceiling sensor. Must have hot and wires in box.

Color: White

Weight: 0.3 lbs

Project:	Type:
Prepared By:	Date:

Technical Specifications

Compliance

UL Listed:

Indoor applications Smart Box & Tuff Dome Wet locations

Other

Compatibility:

Compatible with most electronic ballasts. Not compatible with instant start ballasts. Can be wired in parallel.

1-Year, No-Compromise Warranty:

RAB warrants that our LED products will be free from defects in materials and workmanship for a period of one (1) year from the date of delivery to the end user, including coverage of light output, color stability, driver performance and fixture finish. RAB's warranty is subject to all terms and conditions found at rablighting.com/warranty.

Electrical

Maximum Energy Savings:

Light only when you need it. No ON switch so lights are never Left on by mistake.

Incandescent & Fluorescent Watts Switched:

800W @ 120 volts

Ratings:

6.7 amps.

Power Consumption:

Negligible

Manual Switch:

On - Manual / Off - Auto

Wiring:

Hot & common

Optical

Coverage Area:

1000sf

Sensor Settings

Time Delay:

8 seconds to 15 minutes

Ambient Light Sensing:

n/a

Adjustments:

Time

Detection:

180° view covers 1000 sq. ft.

Dimensions

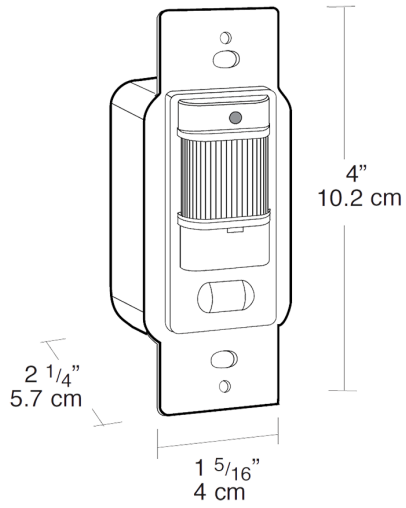

Features

- Sensitive 180° view passive infrared motion detector keeps lights on only when rooms are in use
- LED detection indicator
- Tough, vandal resistant lens
- Fits decorator wall plates
- Control panel cover only removable with wall plate to prevent tampering
- Manual off/auto switch
- Vandal proof sensor for schools, gyms and high abuse areas