



Project:	Type:
Prepared By:	Date:

Driver Info		LED Info	
Type	Constant Current, Class A	Watts	N/A
120V	N/A	Color Temp	N/A
208V	N/A	Color Accuracy	N/A
240V	N/A	L70 Lifespan	50,000 Hours
277V	N/A	Lumens	N/A
Input Watts	N/A	Efficacy	N/A

Technical Specifications

Performance

Product Type:

Trim Reflector

Description:

Modular commercial downlights with field-adjustable wattage, CCT, and optics. Select from various interchangeable modules, trims, and accessories.

Installation

Mounting:

Twist-lock design to attach reflector trim to compatible LED light engine

Construction

Trim Size:

3"

Trim Shape:

Wall Wash - Round

Trim Reflector:

Smooth reflector constructed from anodized aluminum with powder coated paint finish

Trim Finish:

White Flange and White Reflector

Other

5-Year, No-Compromise Warranty:

RAB warrants that our LED products will be free from defects in materials and workmanship for a period of five (5) years from the date of delivery to the end user, including coverage of light output, color stability, driver performance and fixture finish. RAB's warranty is subject to all terms and conditions found at rablighting.com/warranty.

Compatible Products:

ND22-12
3" Modular Downlight 12W

Compliance

Trade Agreements Act Compliant:

This product is a product of Cambodia and a "designated country" end product that complies with the Trade Agreements Act

Dimensions

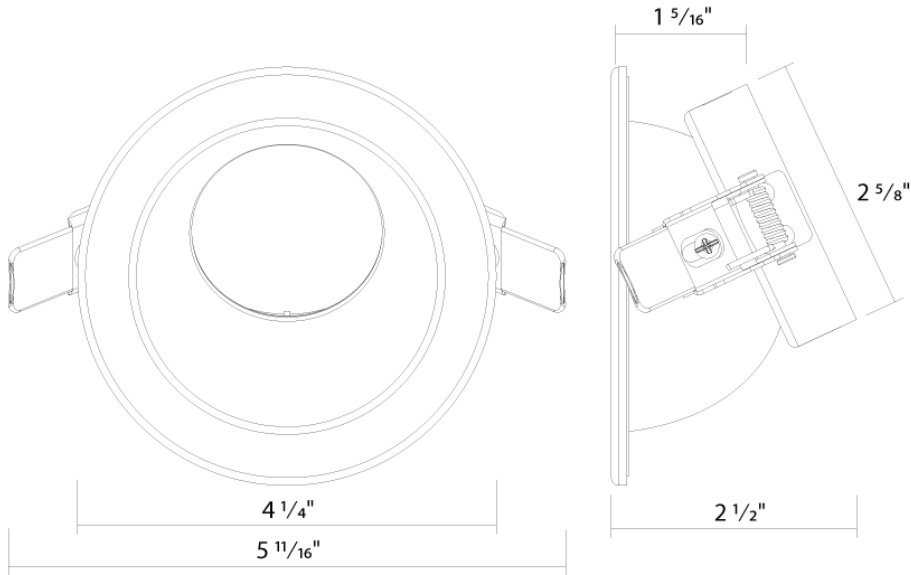

Ordering Matrix

Family	Aperture/Size	Shape	Reflector Finish	Trim
ND22T	3	R	W	WW
	3 = 3" 4 = 4" 4H = 4" 6 = 6" 6H = 6" 8 = 8" 10 = 10"	R = Round S = Square ^{A1}	W = White Reflector + Flange HZ = Haze Reflector + Flange HW = Haze Reflector + White Flange B = Black Reflector + Flange ^{A2}	Blank = Open Flanged Trim WW = Wall Wash Flanged Trim ^{A3}

^{A1} Square not available in 10".

^{A2} Black flange for black reflector only.

^{A3} Wall wash available in 3", 4", 6" (12W) and 6" & 8" (20W, 30W, 50W).

ND22-12 fits 3, 4, and 6"; ND22-20 and ND22-30 fit 4H, 6H, and 8" models; ND22-50 fits 6H, 8", and 10" models.