



Color: Bronze

Weight: 7.9 lbs

Project:	Type:
Prepared By:	Date:

Driver Info		LED Info	
Type	Constant Current	Watts	60/45/35W
120V	0.51A/0.38A/0.30A	Color Temp	3000/4000/5000K
208V	0.30A/0.22A/0.17A	Color Accuracy	81-84 CRI
240V	0.27A/0.20A/0.16A	L70 Lifespan	100,000 Hours
277V	0.23A/0.17A/0.14A	Lumens	5,214-9,140 lm
Input Watts	35.4-62.9W	Efficacy	139.8-153.8 lm/W

Technical Specifications

Field Adjustability

Field Adjustable:

Field Adjustable Light Output:
60W/45W/35W (factory default 60W)
Color temperature (selectable by 3000K, 4000K and 5000K)

Compliance

UL Listed:

Suitable for wet locations

IESNA LM-79 & LM-80 Testing:

RAB LED luminaires and LED components have been tested by an independent laboratory in accordance with IESNA LM-79 and LM-80.

IP Rating:

Ingress protection rating of IP65 for dust and water

Performance

Lifespan:

100,000-Hour LED lifespan based on IESIm-80 results and TM-21 calculations

Wattage Equivalency:

60W: 250W Metal Halide
45W: 175W Metal Halide
35W: 150W Metal Halide

LED Characteristics

LEDs:

Long-life, high-efficiency, surface-mount LEDs

Electrical

Driver:

60W: Constant Current, Class 1, 120-277V, 50/60 Hz, 120V: 0.51A, 208V: 0.30A, 240V: 0.27A, 277V: 0.23A
45W: Constant Current, Class 1, 120-277V, 50/60 Hz, 120V: 0.38A, 208V: 0.22A, 240V: 0.20A, 277V: 0.17A
35W: Constant Current, Class 1, 120-277V, 50/60 Hz, 120V: 0.30A, 208V: 0.17A, 240V: 0.16A, 277V: 0.14A

Dimming Driver:

Driver includes dimming control wiring for 0-10V dimming systems. Requires separate 0-10V DC dimming circuit. Dims down to 10%.

THD:

9.87% at 120V, 14.06% at 277V

Power Factor:

99% at 120V, 89.7% at 277V

Photocell:

120-277V selectable photocell that can be turned on and off.

Construction

Cold Weather Starting:

The minimum starting temperature is -40°F (-40°C)

Maximum Ambient Temperature:

Suitable for use in up to 122°F (50°C)

Housing:

Die-cast aluminum

Lens:

Tempered glass

Finish:

Formulated for high durability and long-lasting color

Green Technology:

Mercury and UV free. RoHS-compliant components.

Installation

Mounting:

Wall mount

Technical Specifications (continued)

Other

5-Year Limited Warranty:

The RAB 5-year, limited warranty covers light output, driver performance and paint finish. RAB's warranty is subject to all terms and conditions found at rablighting.com/warranty.

Dimensions

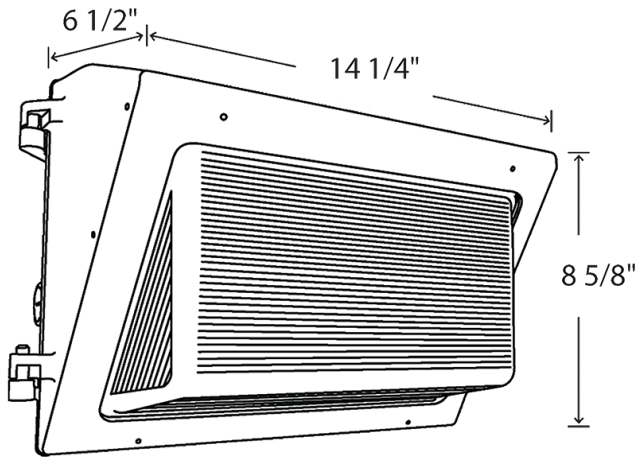

Features

- IP65 Rated
- 100,000-Hour LED lifespan
- 5-Year, limited warranty

Ordering Matrix

Family	Wattage	Color Temp	Finish	Driver	Options
WP2XFU	60				
	29 = 29/20/15W 40 = 40/30/20W 60 = 60/45/35W 80 = 80/60/40W 100 = 100/80/60W	Blank = 3000/4000/5000K	Blank = Bronze	Blank = 120-277V, 0-10V Dimming	Blank = Selectable Photocell /LC = Lightcloud /LCB = Lightcloud Blue /LCBS = Lightcloud Blue w/PIR Sensor /LCBS/MVS = Lightcloud Blue w/MVS Sensor