



Color: Bronze

Weight: 24.2 lbs

Project:	Type:
Prepared By:	Date:

Driver Info		LED Info	
Type	Constant Current	Watts	375/300/240W
120V	3.01A/2.41A/1.93A	Color Temp	3000/4000/5000K
208V	1.74A/1.39A/1.11A	Color Accuracy	82-84 CRI
240V	1.57A/1.25A/1.00A	L70 Lifespan	100,000 Hours
277V	1.40A/1.12A/0.90A	Lumens	39,754-60,553 lm
Input Watts	238.1-376.4W	Efficacy	156-171.6 lm/W

Technical Specifications

Compliance

UL Listed:

Suitable for wet locations

IESNA LM-79 & LM-80 Testing:

RAB LED luminaires and LED components have been tested by an independent laboratory in accordance with IESNA LM-79 and LM-80.

IP Rating:

Ingress protection rating of IP65 for dust and water

DLC Listed:

This product family is listed with the DesignLights Consortium (DLC). Individual SKUs within this family may carry either a DLC Standard or DLC Premium qualification. Please refer to the individual product specification sheet or the DLC Qualified Products List (QPL) at designlights.org to confirm the qualification status of a specific SKU prior to specification or purchase.

Electrical

Driver:

375W: Constant Current, Class 1, 120-277V, 50/60 Hz, 120V: 3.01A, 208V: 1.74A, 240V: 1.57A, 277V: 1.40A
 300W: Constant Current, Class 1, 120-277V, 50/60 Hz, 120V: 2.41A, 208V: 1.39A, 240V: 1.25A, 277V: 1.12A
 240W: Constant Current, Class 1, 120-277V, 50/60 Hz, 120V: 1.93A, 208V: 1.11A, 240V: 1.00A, 277V: 0.90A

Dimming Driver:

Driver includes dimming control wiring for 0-10V dimming systems. Requires separate 0-10V DC dimming circuit. Dims down to 10%.

Surge Protection:

6 kV

Performance

Lifespan:

100,000-Hour LED lifespan based on IESIm-80 results and TM-21 calculations

Optical

IES Classification:

The Type V distribution produces light in a wide and uniform 360° pattern that is perfect for large outdoor areas such as parking lots, corporate parks and retail settings

BUG Rating:

B5 U0 G4

LED Characteristics

LEDs:

Long-life, high-efficiency, surface-mount LEDs

Color Uniformity:

RAB's range of Correlated Color Temperature follows the guidelines of the American National Standard for Specifications for the Chromaticity of Solid State Lighting (SSL) Products, ANSI C78.377-2017.

Construction

Cold Weather Starting:

The minimum starting temperature is -40°F (-40°C)

Maximum Ambient Temperature:

Suitable for use in up to 104°F (40°C)

Lens:

Polycarbonate lens

Housing:

Die-cast aluminum housing, lens frame and mounting arm

Vibration Rating:

3G vibration rating per ANSI C136.31

Technical Specifications (continued)

Effective Projected Area (EPA) (Without Shield):

- 1 Fixture: 0.8 ft²
- 2 Fixtures at 90°: 1.18 ft²
- 2 Fixtures at 180°: 1.6 ft²
- 3 Fixtures at 90°: 1.98 ft²
- 4 Fixtures at 90°: 1.98 ft²

Effective Projected Area (EPA) (With Shield):

- 1 Fixture: 0.84 ft²
- 2 Fixtures at 90°: 1.59 ft²
- 2 Fixtures at 180°: 1.68 ft²
- 3 Fixtures at 90°: 2.43 ft²
- 4 Fixtures at 90°: 2.43 ft²

Finish:

Formulated for high durability and long-lasting color

Green Technology:

Mercury and UV free. RoHS-compliant components.

Installation

Mounting:

Universal mounting arm compatible for hole spacing patterns from 1" to 5 1/2" center to center. Round Pole adapter plate included as a standard. Easy slide and lock to mount fixture with ease. Round pole diameter must be >4" to mount fixtures at 90° orientation.

Other

5-Year Limited Warranty:

The RAB 5-year, limited warranty covers light output, driver performance and paint finish. RAB's warranty is subject to all terms and conditions found at rablighting.com/warranty.

Dimensions

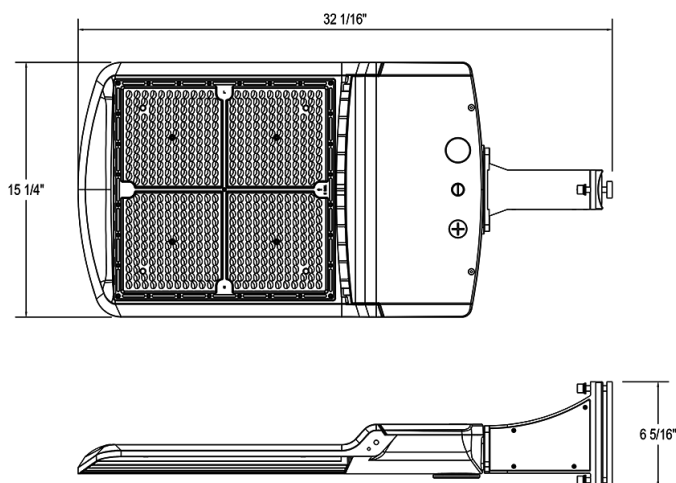

Features

- 0-10V Dimming, standard
- 100,000-hour LED lifespan
- 5-Year, limited warranty

Ordering Matrix

Family	Distribution	Wattage/Lumens	Mounting	Color Temp	Finish	Driver	Options
A17	-	5T	375				
	4T = Type IV 5T = Type V 3T = Type III	70 = 70/60/50W 100 = 100/80/60W 150 = 150/120/100W 200 = 200/180/160W 300 = 300/240/200W 375 = 375/300/240W 480 = 480/400/320W	SF = Slipfitter (Factory installed SF available in 150W) ¹ Blank = Universal Pole Mount	Blank = 3000/4000/5000K CCT Adjustable	Blank = Bronze	Blank = 120-277V, 0-10V Dimming /480 = 480V, 0-10V Dimming	Blank = No Option /3PRS = 3-pin Receptacle and Shorting Cap /7PRS = 7-pin Receptacle and Shorting Cap /MVS = Microwave Motion Sensor /LCBS = Lightcloud Blue w/PIR Sensor /LCBS/MVS = Lightcloud Blue w/MVS Sensor

¹ 1Slipfitter Mount available on 150W only
 Type II distribution available as special order.
 Wall mount and roadway arm mount available as optional accessories.