



Project:	Type:
Prepared By:	Date:

Driver Info		LED Info	
Type	Constant Current	Watts	15W
120V	0.14A	Color Temp	2700/3000/3500/4000/5000K
208V	N/A	Color Accuracy	90 CRI
240V	N/A	L70 Lifespan	N/A
277V	N/A	Lumens	1,640 lm
Input Watts	15W	Efficacy	109.3

Technical Specifications

Performance

Product Type:
Deep Regress Wafer

Description:
Deep regress remote driver downlight looks like a traditional recessed retrofit but without the need of a traditional downlight housing.

Wattage Equivalency:
120W Incandescent

Input Wattage:
15W

Lumens:
2700K @ 1,525lm; 3000K @ 1,562lm; 3500K @ 1,627lm; 4000K @ 1,662lm; 5000K @ 1,685lm

Efficacy:
2700K @ 108lm/W; 3000K @ 112lm/W; 3500K @ 118lm/W; 4000k @ 119lm/W; 5000K @ 118lm/W

L70 Lifespan:
50,000-Hour LED lifespan based on IES LM-70 results

Driver:
Constant Current, Class 2, 60 Hz, 120V: 0.14A

Electrical

THD:
≤20%

Power Factor:
≥0.9

Dimmable:
Yes, dims down to 10% on compatible TRIAC/ELV systems. See Dimmer Compatibility List on rablighting.com.

Input Voltage:
120V
120-277V when paired with HAD6/D10 driver, sold separately

Operating Frequency:
60 Hz

Input Current @ 120V (mA):
137mA

Operating Temperature:
-4°F to 104°F (-20°C to 40°C)

Flicker:
5%

LED Characteristics

Beam Angle:
90°

Color Temperature:
Field adjustable via dip switch
2700/3000/3500/4000/5000K

Color Accuracy (CRI):
>90 CRI

R9 Value:
High color performance with R9 greater than or equal to 50

Color Consistency:
4-step MacAdam Ellipse binning to achieve consistent fixture-to-fixture color

Color Stability:
LED color temperature is warrantied to Shift no more than 200K in color temperature over a 5-year period

Color Uniformity:
RAB's range of Correlated Color Temperature follows the guidelines of the American National Standard for Specifications for the Chromaticity of Solid State Lighting (SSL) Products, ANSI C78.377-2017.

Technical Specifications (continued)

Installation

Mounting:

Utilizes a remote driver with built-in junction box and quick disconnect; Eliminates the need for traditional downlight housings

Construction

Size:

6"

Shape:

Round

Finish:

White

Enclosure Material:

Metal

Trim Style:

Regressed Baffle

Remote Driver/ Junction Box:

Aluminum driver / junction box with captive hinged junction box cover.

Listed for (6) #12 AWG 90°C splice conductors, 2-in, 2-out plus (2) ground.

Integral keyhole mounting slots facilitate direct mounting to building structure or new construction mounting frame.

Lens:

Polycarbonate light diffuser distributes light evenly and smoothly for general lighting applications

Cut Out Template Size:

6 5/16"

Air Tight:

Housing certified Air Tight as per ASTM-E283

Compliance

Listings:

UL Listed

Environment:

Suitable for use in dry, damp, and wet environments.

IC Rated:

Suitable for direct contact with insulation.

Type IC inherently protected, suitable for direct contact to air permeable insulation and cULus listed for damp locations. Not for use in direct contact with spray foam insulation, consult NEMA LSD57-2013.

Plenum Rated:

Classified by UL 2043 Fire Test for heat and visible smoke release for discrete products and their accessories installed in air-handling spaces.

Energy Star Approved:

This product is ENERGY STAR® Version 2.2 Certified.

Certification Model Number:

DLW0103(WFD6B)

T20 Compliant:

No, this product does not meet California Title 20 requirements.

California Title 24 JA8 Compliant:

Can be used to conform with the requirements of California Title 24 Part 6.

California Energy Commission (CEC) Status:

Lawful for Sales in California

NEC Compliant:

Suitable for use in closets. Compliant with NEC Sec. 410.16 (A)(1) and 410.16 (C3).

IESNA LM-79 & LM-80 Testing:

RAB LED luminaires and LED components have been tested by an independent laboratory in accordance with IESNA LM-79 and LM-80.

RoHS:

Mercury and UV free. RoHS-compliant components.

FCC:

Complies with Part 15 of the FCC Rules

Trade Agreements Act Compliant:

This product is a product of Cambodia and a "designated country" end product that complies with the Trade Agreements Act

Energy Star ID:

3555554

Other

Accessories:

[DLPLATE/WFR3468/NB](#)

Mounting Plate w/nailer bar

[DLPLATE/WFR3456](#)

Mounting plate for 3", 4", 5" and 6"

[DRI-EMB-15S-LV](#)

2-n-1 Driver + Battery Backup

5-Year, No-Compromise Warranty:

RAB warrants that our LED products will be free from defects in materials and workmanship for a period of five (5) years from the date of delivery to the end user, including coverage of light output, color stability, driver performance and fixture finish. RAB's warranty is subject to all terms and conditions found at rablighting.com/warranty.

Dimensions

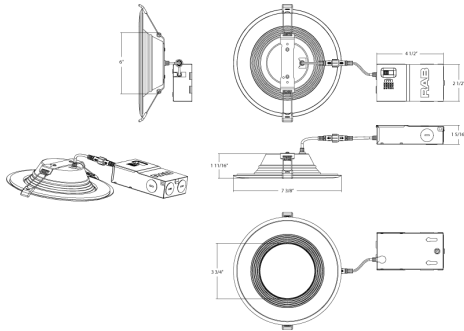

Features

- 5 color temperatures in 1 SKU (2700K, 3000K, 3500K, 4000K, 5000K)
- No recessed housing or j-box required
- Dimmable on TRIAC/ELV, see Dimmer Compatibility List
- Suitable for indoor and outdoor use in dry, damp, and wet environments
- 50,000 hr lifespan and 5-year no-compromise warranty

Ordering Matrix

Family	Size (Wattage)	Shape	CRI/Color Temp	Driver	Finish	Trim
WFD	6					B
	4 = 4" (13W) 6 = 6" (15W)	Blank = Round	Blank = 90CRI, 2700/3000/3500/4000/5000K CCT Adjustable	Blank = 120V	Blank = White	Blank = Smooth B = Baffle